

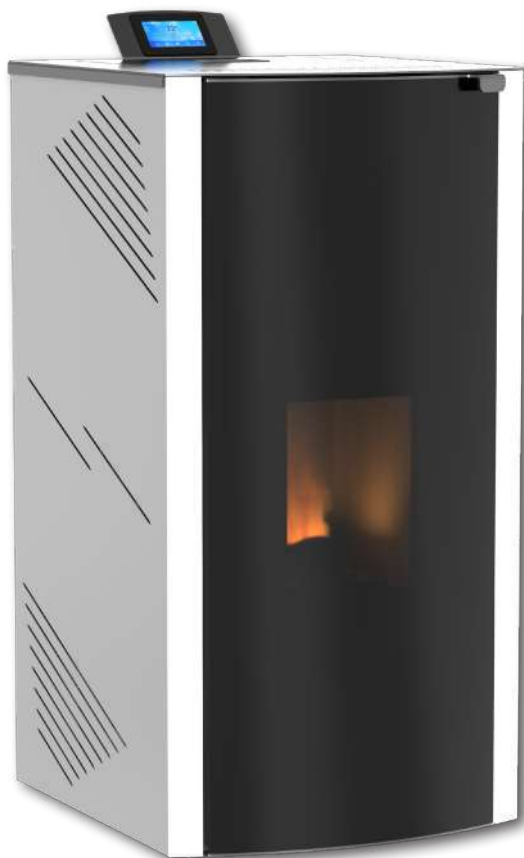

ONYX HYDRO 12/18/24/30 Pellet stove
Assembly and exploitation manual



The present stove is designed and manufactured according to
Standards: BNS (Bulgarian National Standard) EN 14785-2006

Observing the prescriptions of the present manual is in the user's favour and is one of the warranty conditions. Compliance with this instruction is in the interest of the consumer and one of the warranty terms.

INSTRUCTIONS FOR SECURITY:

- This appliance is not intended for use by people (including children) with limited physical, sensory or mental abilities or lack of experience and knowledge. The installation must be performed by a qualified expert in the field of heating installations or authorized by "Mareli Systems' service. The place and way of connecting the stove should be selected carefully in accord with the safety instructions. Install away from flammable objects!
 - Before starting any operation, the user must read and fully understand the contents of this instruction manual. Incorrect setup may cause hazardous conditions and / or incorrect function of the stove;
 - Do not wash the stove with water. Water can get inside the fireplace and damage the electronics and cause an electric shock;
 - Do not put clothes to dry on the stove. Any clothes hangers and other objects must be located within a reasonable distance from the fireplace. Fire hazard;
 - The user is fully responsible for the proper use of the product which exempts the company from liability of any users errors or misbehaviour or omissions;
 - Any intervention or replacement that is made by unauthorized people or using non original spare parts for the product can be risky for the user and release the company from all liability;
 - Most surfaces of the stove are extremely hot (the door handle, glass, flue pipe, etc.). Avoid contact with these parts before assuring yourself that you use temperature resistant gloves as well as suitable temperature resistant instruments;
 - Under no circumstances should the fire be ignited with the door open or broken glass;
 - The product must be electrically connected to a system equipped with an effective earth conductor. (Must be grounded);
 - Turn off the stove in case of failure or malfunction;
 - All unburned pellets in the burner after each unsuccessful attempt ignition must be removed before a new ignition;
 - When installing the product all fire safety requirements must be respected
- If there is a fire in the flue pipe, extinguish the stove, disconnect the power cord and never open the door. Call competent authorized service technicians;
- Do not light the stove with flammable materials if the ignition system failed;
 - Periodically check and clean the smoke outlet ducts of the stove (connection to the flue pipe);
 - Pellet stove is not a cooker;
 - Always keep the cover closed;

SAFE DISTANCES:

When installing the product a safe distance of at least 600 mm must be respected. This distance applies to the product located near materials of B or C flammability level. The safe distance is doubled if the product is close to materials of C3 combustion level.

1. PURPOSE

The stove is purposed to heat domestic and public premises by the means of pellets. The stove is equipped with a steel water jacket designed for heating systems with water temperature up to 90° C at a maximum super pressure up to 0,15 Mpa. Tests are run at pressure of 0,3 Mpa.

The stove is designed and manufactured to work with A-class pellets only (DIN plus 51731) with the following characteristics:

- Material 100% pure conifer or broad-leaf wood;
- Diameter Φ 6/8 mm;
- Length 20-30mm;
- Calorie capacity 5.2 kW/kg;
- Ash content < 8%;



The use of pellets with characteristics different from the recommended may result in power decrease, unstable and inconsistent work of the stove.

What are the pellets.

The pellets are produced by compressed wooden waste left from the production of various furniture, sawmills and others. This type of fuel is environmentally friendly because in the production process no agglutinate agents (glues, resins and others) are added. Actually, the integrity of the pellets is guaranteed by the lignite – a natural ingredient contained in the wood itself. While the wood has a calorie capacity of 4.4 kW/kg (15% humidity at 18 months drying), the pellets have 5.2 kW/kg.



Info: To ensure the proper work of the stove the pellets must be stored in a dry place!

Recharging of pellets can be done during work, with the following sequence:

1. Open the bunker (located at the top rear of the product);
2. Fill the hopper, using non-combustible container;
3. Close the lid of the bunker;

Attention!!! Use gloves! Beware of hot surfaces!

2. TECHNICAL DATA

Maximum output	KW	12	18	24	30
Heated area	m ³	250	350	500	600
Height H	mm	1047	1127	1127	1177
Width W	mm	534	584	584	624
Depth D	mm	631	631	631	672
Pellet bunker volume	kg	19	30	30	30
Fresh air pipe	φ mm	60	60	60	76
Exhaust gas pipe	φ mm	80	80	80	80
Weight	kg	165	175	175	192
Fuel type		Pellets Φ6-Φ8	Pellets Φ6-Φ8	Pellets Φ6-Φ8	Pellets Φ6-Φ8
The chimney draft	Pa	12	12	12	12
Electrical consumption	V/Hz	60/310	60/310	60/310	60/310
Electrical supply	V/Hz	230/50	230/50	230/50	230/50
Water jacket capacity	L	30	41	41	48
Working pressure	bar	0,5-2,0	0,5-2,0	0,5-2,0	0,5-2,0
Space heating output	Kw	1	2	3	4
Working at environment temperature	C	5-40	5-40	5-40	5-40
Humidity at 30° C environment temperature	%	85	85	85	85
Energy conversion efficiency	%	>93	>94	>94	>93
Co Emissions	Mg/m3	<300	<300	<300	<300
Temperature of the flue gas	C	91	129	131	119
Max. water temperature	C	90	90	90	90

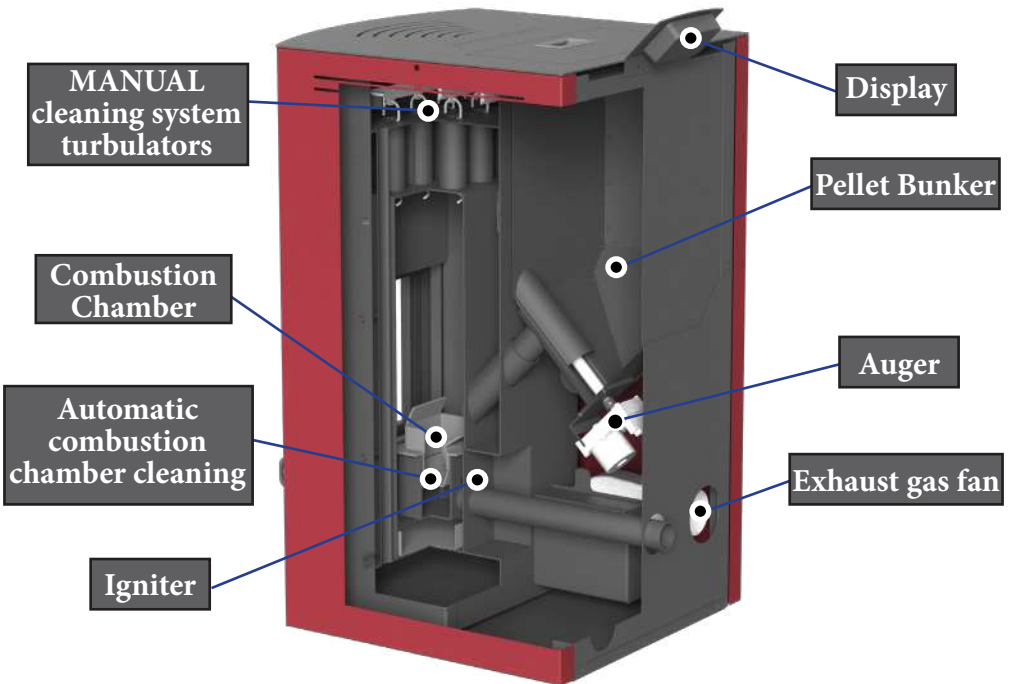

3. ASSEMBLY

3.1 General conditions.

All national, regional and European requirements for safe operation of the appliance must be respected during installation and operation.

Prior to installation, load capacity of the place where the stove will be intended must be ensured. The weight of the stove is specified in the technical data table. To ensure the correct and safe operation of the stove, the following conditions must be met:

The installation of the stove and its accessories must be carried out by authorized persons.

The floor where the stove is installed should be flat and horizontal, made of fire-resistant materials at least 1500 mm in front of the fireplace and not less than 400 mm on both sides and at the back of the wall.

Minimum distances from the wall to the stove should be at least 400 mm. The minimum space in front of the fireplace should be 1500 mm. The minimal distance of the stove from combustion materials should be no less than 1500 mm.

The door of the fireplace should be closed tightly during the work process. Opening it during work is absolutely forbidden.

When installing the stove, the connections between the individual pipes and the chimney rooftop must be dense.

When the fire is first ignited, a smell occurs as a result of the paint being heated.

The fireplace is painted with heat-resistant paint, which achieves its ultimate resistance after repeated use of the stove. THEREFORE KEEP OUTSIDE INTERACTIONS WITH THE COATING TO A MINIMUM in order not to damage it.

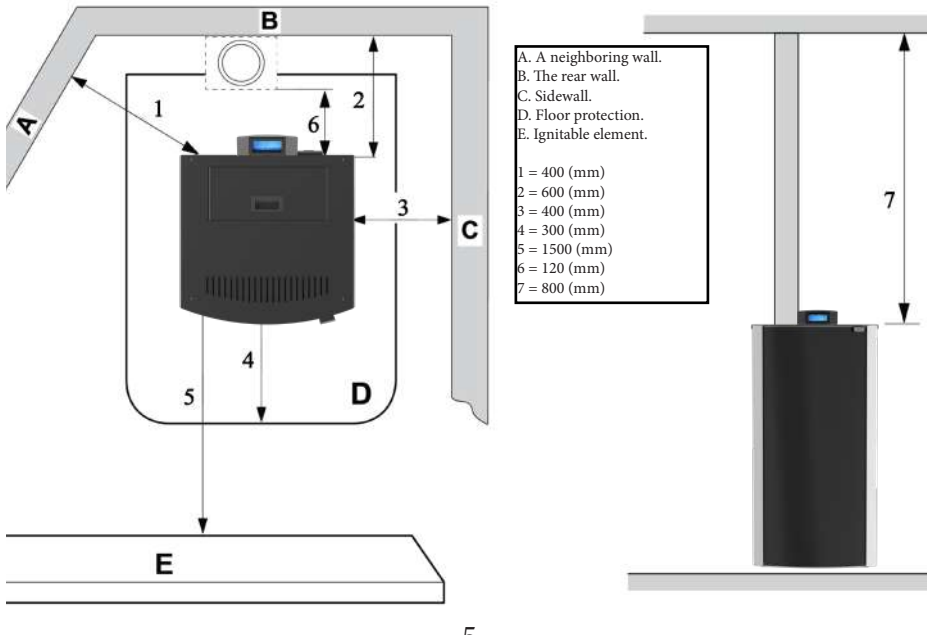

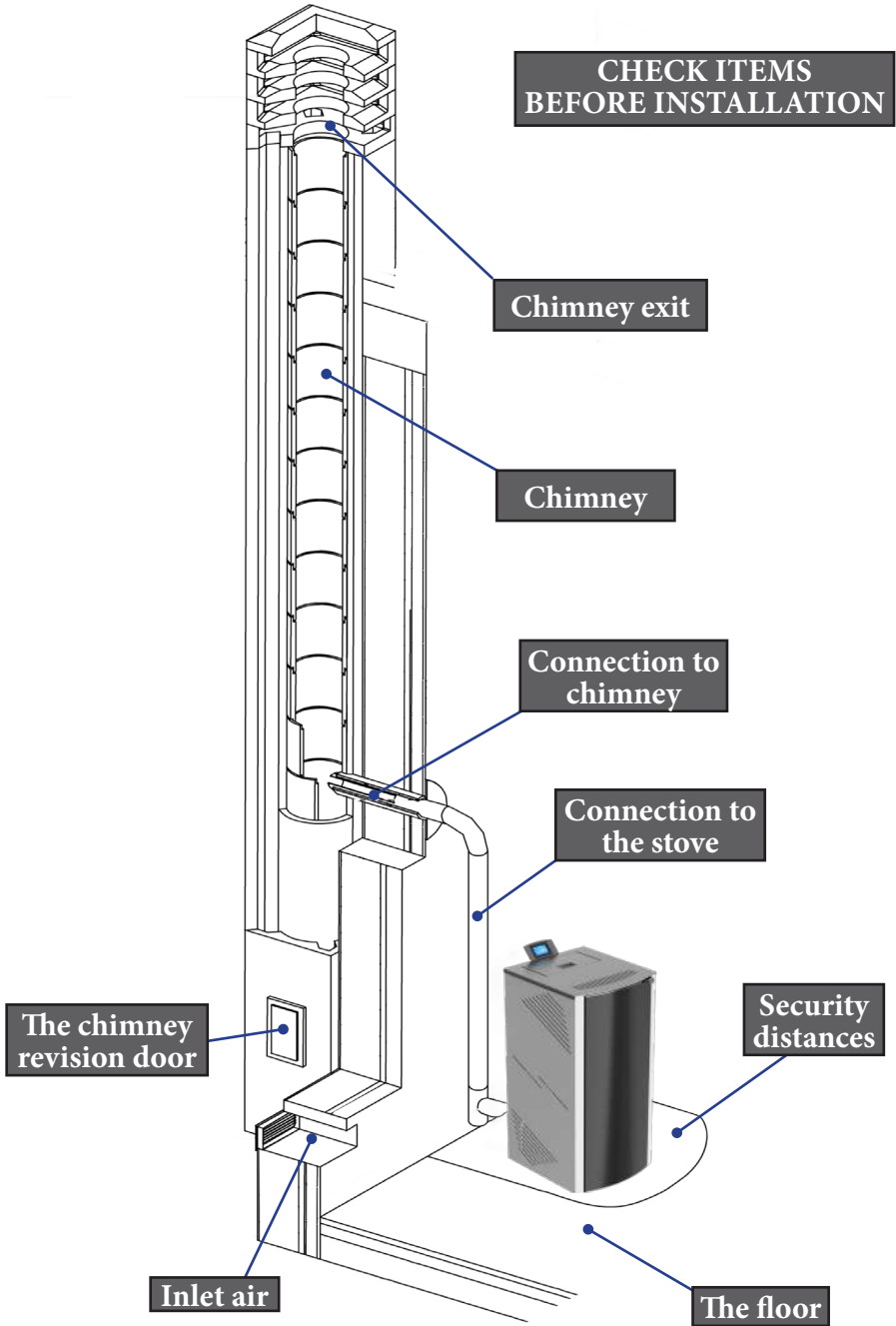

3.2 Basic rules and prescriptions.

The stove with water jacket operates on water heating boiler principle.

The advantage of this type of heating system is the maximum utilization of the heat that is produced during the combustion process. With this method the heat from the combustion chamber is taken to remote and hard to reach for a normal heat exchange premises in order to maintain an even temperature and warmth comfort.

- Ensure that every branch and element of the installation is airtight at every single moment of its exploitation.
- All elements of the installation must be protected from freezing, especially if the enlarging pot or other parts are situated in non-heated premises.
- The circulation pump can be chosen by the capacity required by using the following formula:

$G=0,043 \cdot P$, (m³/h), in which:

P, kW is the heat output of the water jacket. The circulation pump can be turned on and off by the means of a thermostat in combination with an electric switch

- The first service cleaning of the pump's filter must be done immediately after testing the installation.
- If an old installation is going to be used it must be washed several times to ensure the removal of any accumulated dirt on the surfaces of the water jacket.
- Do not drain the circulating water of the installation during the non-heated season.
- Chemical treatment of the circulating water is not recommended.

Chart 1 is a basic combined chart for heating with solid fuel stove, electrical boiler equipped with water serpentine and a solar panel. For economy and efficiency of the system and a constant availability of cheap hot water a qualified assembly of the automatic shifter controlling the thermal flows to and out of the solar panel and the boiler is required.

Chart 2 shows a one storey heating with a compulsory circulation. The advantage of this chart is that the water-conducting elements can be hidden.

The enlarging pot must have a direct atmosphere connection which means that it must be placed on the highest spot in the system. Its capacity can be determined as 0,1 part of the total capacity of the system.

The filling or unloading of the system is done via a hose through a facet mounted in the lowest area. Mounting a membrane enlarging pot is permitted when constructing a closed type system. During the initial 3-4 start-ups a condensation on the surfaces of the water jacket may occur which depending on the fuel's humidity and the temperature of the incoming water may reach 0,3 liter on a single start-up. The accumulating char reduces the temperature difference and the condensation.

- "Mareli Systems" provides a warranty and out of warranty service and replacement of the water jackets.
- The warranty is not valid in case of a stove with a swollen water jacket which is a result of pressure increase in the system and improper connecting.
- The water jackets are tested under pressure of 400 kPa (4 bar).

It is recommended that the assembly is performed by an authorized specialist.

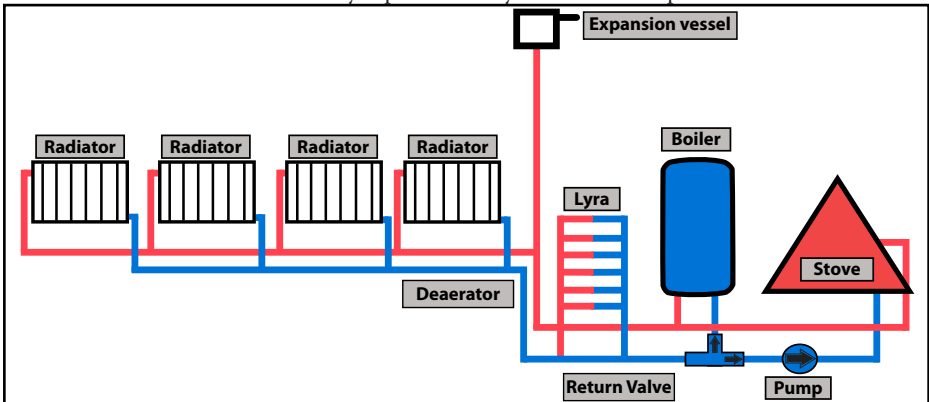

Mareli Systems

3.3 Assembly of the duct components.

Duct components and pipes

For the assembly of the duct pipes the use of non-flammable materials, resistant to the flammable products and condensation is obligatory. The assembly must be performed in such a manner so it guarantees the airtight sealing and prevents condensation. If possible, avoid adding horizontal sections. Direction shift is done by using knee joints with a max angle of 45° . For heating devices equipped with a smoke ventilator, i.e all of the "MARELI" stoves, the following instructions must be observed:

- Horizontal sections must have a minimum incline of 3° upwards;
- The length of the horizontal sections must be as short as possible, but without exceeding 3 m;
- More than four direction shifts are forbidden, including the cases where a T-shaped element is used;
- The duct components must be airtight and to be insulated if extending outside the premises in which the fireplace is installed;
- The duct components must allow a soot cleaning;
- The duct components must have a constant section. A section change is allowed only in the chimney joint;

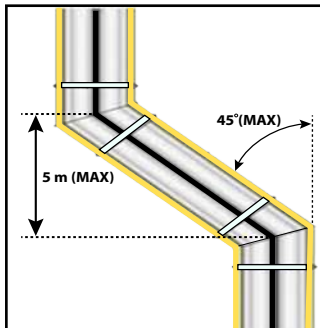
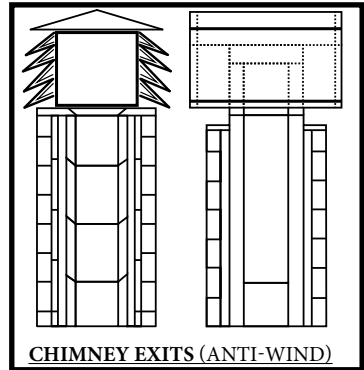

Chimney

The chimney or the duct component must conform with the following requirements: to be airtight, waterproof and properly insulated, to be constructed with materials resistant to the normal mechanical wear and to the heat coming from the combustion products and condensation.

- To be kept away from flammable materials.

The recommended chimney draft at work - from 12-20 Pa.

Attention!!! In case of a fire hazard turn off the product from the display. This will stop the oxygen flow to the product.

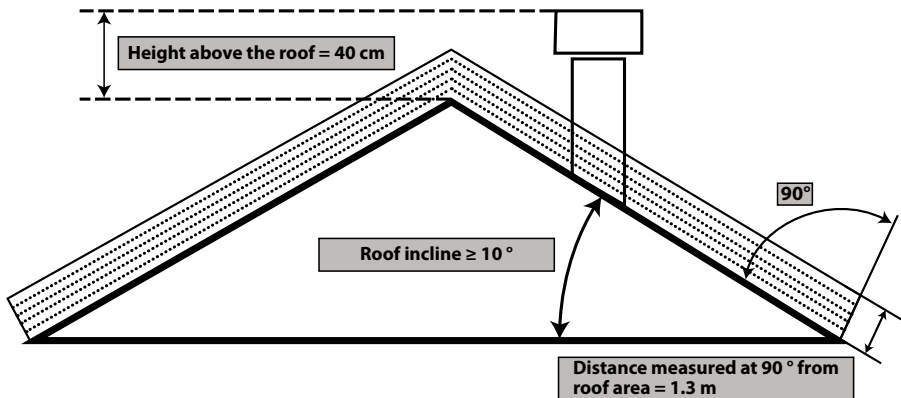

3.4 Types of connection to the chimney

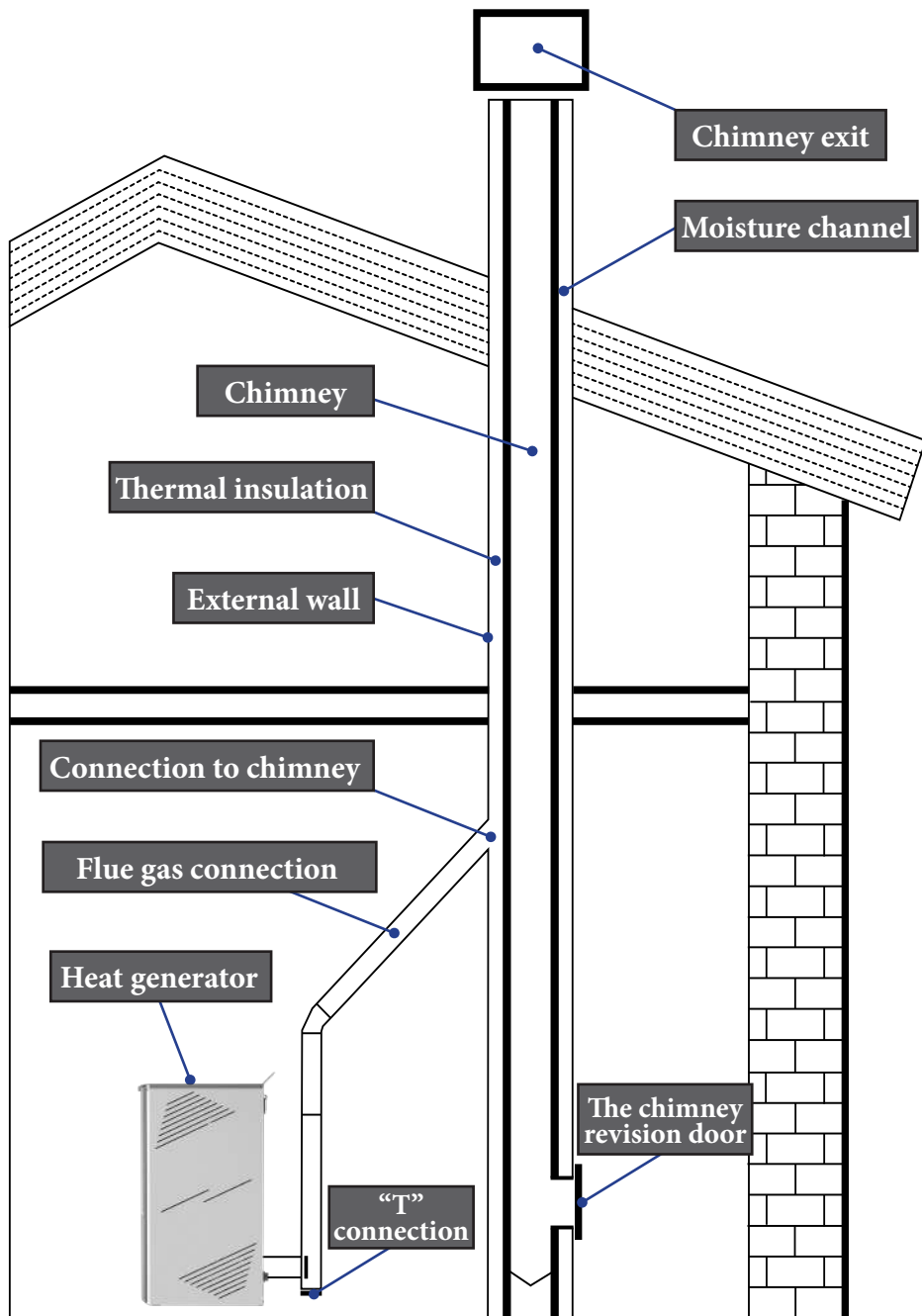

Mareli Systems

3.5 Air intake

Suction pipe or air intake is placed in the back and has a circular section with a diameter of 48 mm.

The combustion air can be aspirated:

- From the camera, as long as it is near an air intake communicating with the outside wall having a minimum area of 100 cm², properly positioned and protected by a grid.
- Or by connecting directly outside with a suitable tubing having an inner diameter of 48 mm and a maximum length of 1.5 M.2

4. Cleaning

Cleaning the fireplace should be done only when cold. The cleaning of the combustion chamber must be carried out daily. For this purpose, make sure the fireplace has ceased operation and is completely cold. Pull up the combustion pot and remove it from the stove and then clean it from soot. When removed fuel pot at the bottom of the combustion chamber opens a hole designed for the accumulated ash. Collect ashes in the ashtray and return fuel pot in place and then close the door. The fireplace is ready for operation.

Cleaning of flues and chimneys are conducted once every 1.5 tons of fuel used.

Once clean audits and close the cleaning lid. Check that the bolts are tightened well. Every time you open check for violations of the isolation seal. If this happens do not use the product until the isolation seal is repaired.

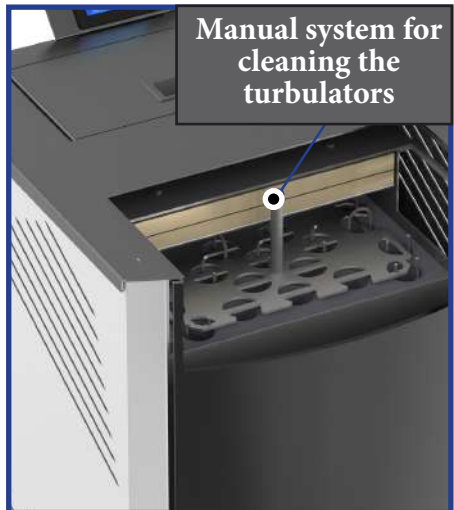

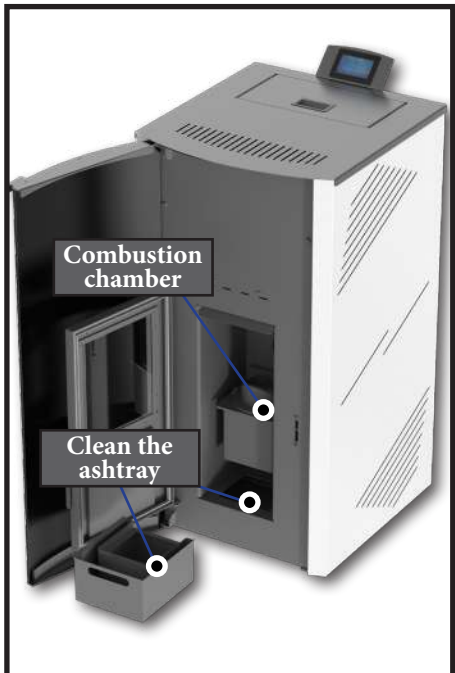

Maintenance program				
	At each ignition	Weekly	Twice per season	Annual
Combustion chamber	V			
Clean the ashtray		V		
Glass		V		
The Door		V		
Clean the flue gas outlet			V	V
Door seals				V
Chimney			V	V

5 Safety and unexpected risks

Terms of danger may arise in the following cases:

- Automated pellet stove is used incorrectly;
- The unit is installed by unqualified personnel;
- The safety instructions described in this management are not met;

Unforeseen risks:

Pellet fireplace “Mareli” has been designed and manufactured in accordance with the safety requirements on the national, regional and European levels. Although considered possible risks arising from improper use, you may experience the following risks:

- Risks of spreading combustion outside fireplace - opening the door of the chamber of the fireplace may fall hot / burning particles (as hot ash and small particles burning coal), which could lead to a fire in the heated room. It is therefore necessary that the product always works with a tightly closed door. It can only be opened when the product has completely cooled down;
- Risks of burns caused by high temperatures as a result of the combustion process in the combustion chamber and / or access to the door of this burn chamber when the product is not completely cool;

In case of fire hazard the product should be stopped by the controller and power supply until the cause of the problem is determined.

K400 TOUCH SCREEN DISPLAY

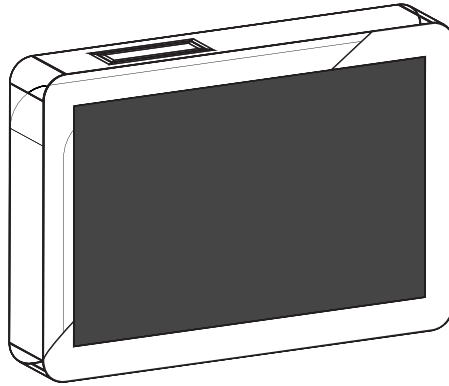

1. HOMEPAGE

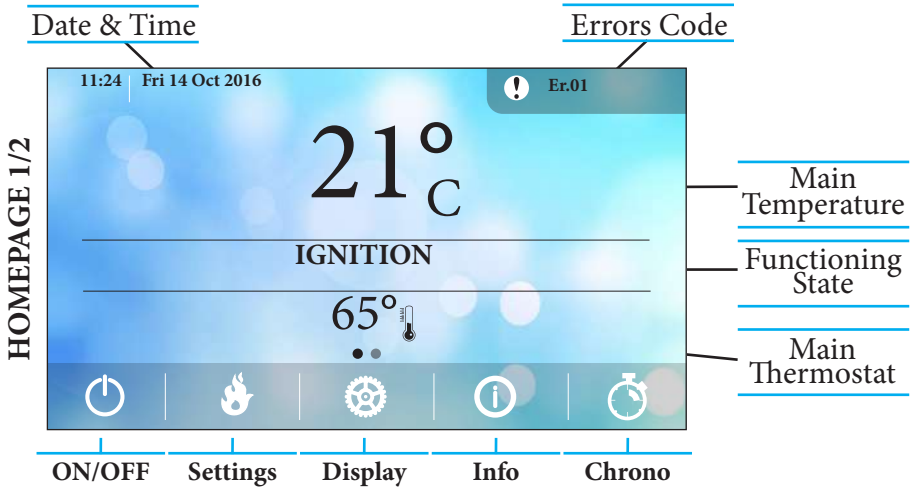

Main Commands



In order to go to Homepage 2 a horizontal swipe must be performed to the right side of the screen.

HOMEPAGE 2/2



System activity LEDs



The Quick visualization of the system main function is accessed through a vertical swipe to the top side of the screen.

SPECIAL LEDs

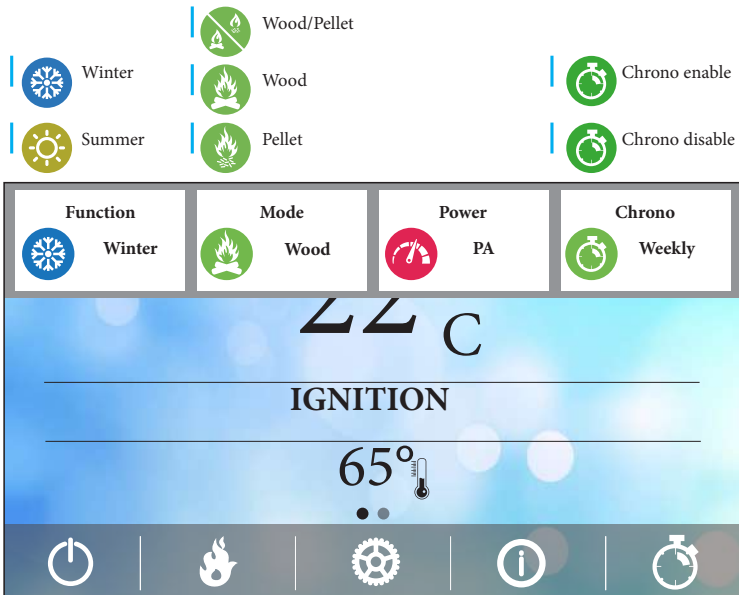

Quick visualization of the system main function

2. ERROR LIST



Blocking or non-blocking error is highlighted with a **!** and the related error code. When pressed the error window opens

Error List	
Er10	10:50
Er 53	11:20
Er 53	11:20
Er 53	11:20
Er 53	11:20

By clicking on (**i**) you can see the errors stored by date / time and description

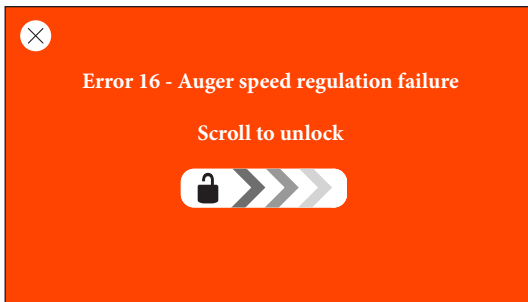

When this message is on screen this means that the product is in blocking mode and you can remove the error. You can do this by swiping to the right in the center of the screen.

4. MAIN COMMANDS

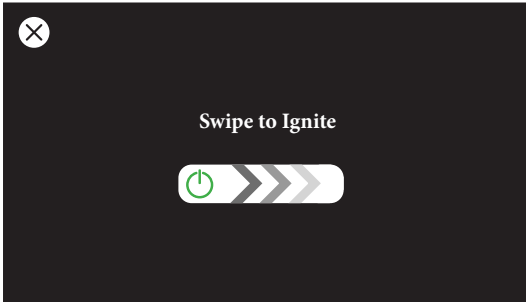

ON/OFF Menu

Screen image :

- System power ON
- System power OFF
- Alarms reset

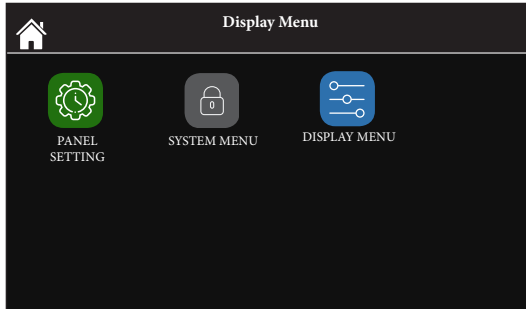

Display Menu

In this screen you can view all the variables of the control panel.

Furthermore, it is possible to access the SYSTEM MENU which is reserved exclusively for technical personnel.

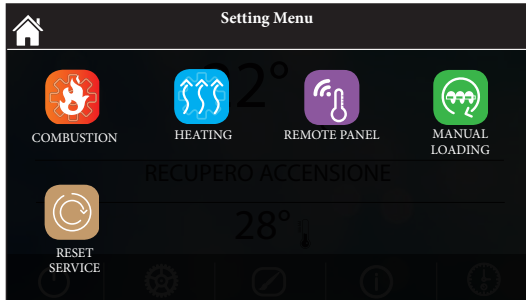

Settings Menu

From this screen it is possible to view all the variables for the proper functioning of the heating system.

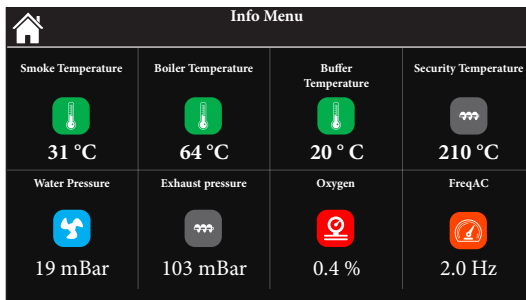

Info Menu

From this screen it is only possible to display the values of all inputs and outputs.

5. CHRONO

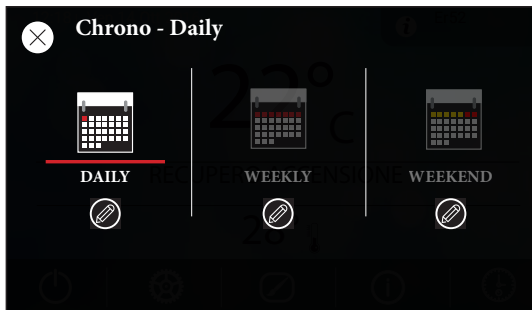

To select the desired CHRONO program, press on the respective tabs:

- Daily
- Weekly
- Weekend.

To change the chrono program, press on .

If the Chrono function is disabled all the tabs are grey.

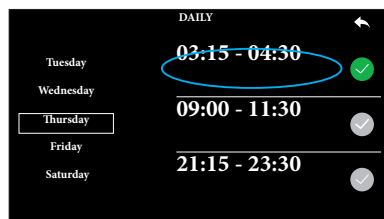

To edit the time slots, press on the corresponding Frame Time.

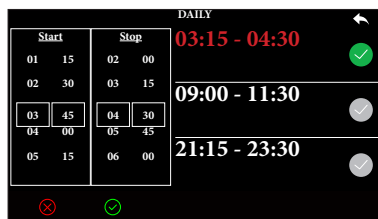

Scroll Up or Down to change the System on/off Time

5. INTERNAL MENU STRUCTURE

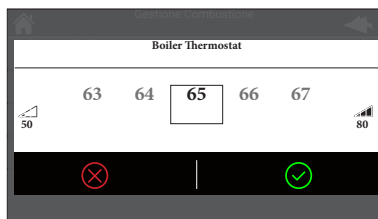
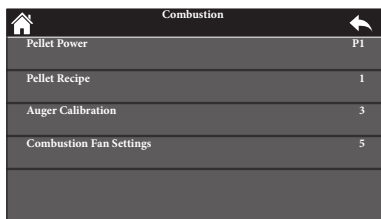

Here are the types of interface used to access, select and modify menu items.

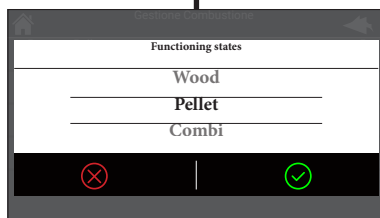

5. INTERNAL MENU STRUCTURE



From the display Menu the user can access the panel settings and select one of 24 languages.



Brightness.



Minimum brightness: this function allows you to choose the minimum brightness level which the device automatically sets to after 30 sec. of inactivity.



Standby display: if enabled, this function will set the screen to standby after 1 minute of inactivity.



Control panel address: password-protected menu (1810) and used to set the control panel address.
In modbus, the address reserved for the local control panel is 16. The address of the first remote control panel is 17 and subsequently the others according to the number provided by the system.



Control panel restart: this function allows the control panel to be restarted.



Sound: this function allows the user to enable / disable the sounds emitted from the control panel.



Delete error list: this password protected function (the same as in the technical menu) allows the user to delete the list of errors recorded by the control panel. The errors recorded are 64.

Nodes list: this menu allows the user to view all the devices connected via Modbus, with their related firmware and revision.

Wallpaper: menu used to select wallpapers loaded in the device. 8 backgrounds are available.

Control panel info: this menu allows the user to view the firmware and revisions that make up the control panel in detail.

ALARMS

Er01 - Security Error High Voltage 1. It may also intervene with the system off;
Er02 - Security Error High Voltage 2. It can only intervene if the Combustion fan is active;
Er03 - Extinguishing for low exhaust temperature or missing light in the brazier;
Er04 - Extinguishing for water over temperature;
Er05 - Extinguishing due to high exhaust temperature;
Er06 - Pellet Thermostat open (flame return from the brazier);
Er07 - Encoder Error. The error may occur due to lack signal from Encoder;
Er08 - Encoder Error. The error can occur due to problems of adjustment of the number of revolutions;
Er09 - Water pressure low;
Er10 - Water pressure high;
Er11 - Clock Error. The error occurs due to problems with the internal clock;
Er12 - Extinguishing for ignition failure;
Er15 - Extinguishing due to power failure for more than 50 minutes;
Er16 - RS485 communication error (Display);
Er17 - Adjusting the Air Flow Failed;
Er18 - No more Pellet in the bunker;
Er23 - Boiler probe or Back boiler probe or probe Buffer open;
Er25 - Engine cleaning brazier broken;
Er26 - Engine cleaning broken;
Er27 - Engine cleaning 2 broken;
Er34 - Depression below the minimum threshold;
Er35 - Depression above the maximum threshold;
Er39 - Sensor Flowmeter broken;
Er41 - Minimum air flow in Check Up is not reached;
Er42 - Maximum air flow exceeded;
Er44 - Open door error;
Er47 - Error Encoder Auger: missing signal Encoder;
Er48 - Error Encoder Auger: Auger regulation speed not achieved;
Er52 - Error Module I/O I2C;
Er57 - Test 'Forced Draught High' in Check Up fail;
Service - Service error. It notifies that the planned hours of functioning is reached. It is necessary to call for service.

MESSAGES

Description	Code
Anomaly of the probes checking, during Check Up phase.	Sond
Room temperature greater than 99 °C.	Hi
This message notifies that the planned hours of functioning are reached.	Clean
Door Open.	Port
The message appears if the system is turned off during Ignition (after Preload) not manually: the system will stop only when it goes in Run Mode.	Ignition block
Periodical Cleaning in progress.	Cleaning on
No communication between motherboard and keyboard	Link Error

ONYX HYDRO (MB250)

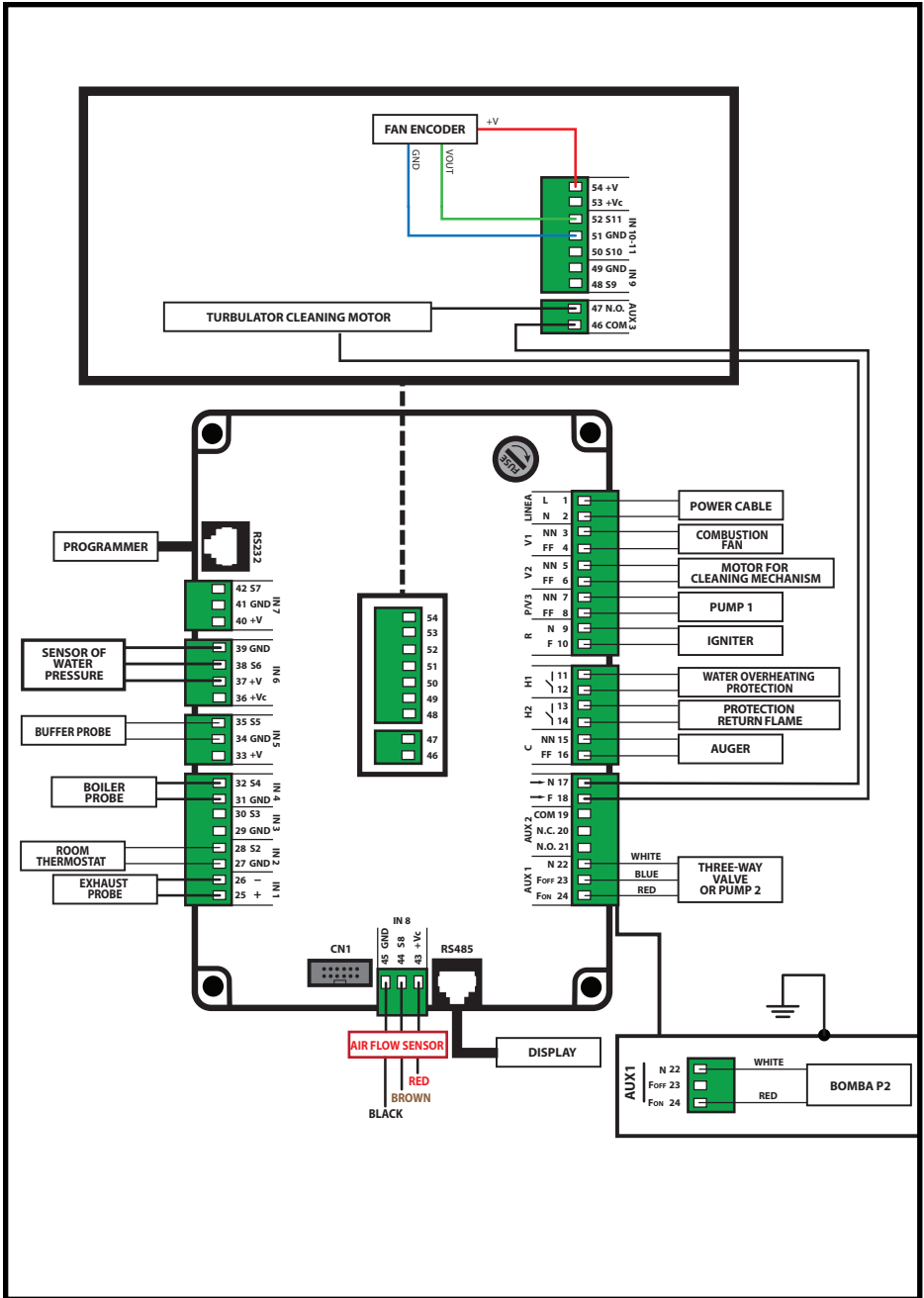

Mareli Systems

Mareli Systems

Industrial Zone
Simitli, 2730
Region Blagoevgrad
Bulgaria

info@mareli-systems.com
www.mareli-systems.com

MARELI SYSTEMS disclaims any responsibility for possible inaccuracies contained in this manual if they are due to printing or transcription errors. We reserve the right to make any change that appears to be necessary or useful without harm the essential characteristics.
